



Available finish:- Black

Read these instructions before commencing installation. Please give these instructions to the owner/occupier after installation to retain for future reference/maintenance.

IP65 IK08 240VAC~50Hz 1.0m 200W LED

These fittings are Class I and must be Earthed

**Important Information**

It is recommended that these luminaires are installed and fitted by a qualified electrician ensuring the installation complies with current IEE wiring regulations & local building control. These products are designed for connection to a 240VAC~50Hz supply. Any faulty, broken or damaged luminaires should be replaced immediately. KSR will not accept responsibility for any claims arising from a poor installation.

Please Note: The limited warranty shall be deemed null and void in the following circumstances: Failure by the installer, end user or any third party to exercise caution to protect any covered product or part from outside damage, humidity conditions, fluctuations in the electrical system or physical abuse as well as failure related to workmanship in the installation of the products or parts.

**Important User Advice**

Always safely isolate the mains supply before installing/servicing.

Please note this luminaire is Non Dimmable.

General maintenance and cleaning should be performed at least quarterly.

Clean product outer using a damp cloth, the glass can be cleaned with hot soapy water, dried and buffed to a shine. Protection from exposure to natural elements in the form of a non-abrasive water repellent protection (car wax). Grease screws and nuts with a suitable waterproof repellent will ensure the product gives you a long lasting trouble free life/finish. At the end of life the luminaire is classed as WEEE under directive 2014/30/EU and should be disposed of in accordance with local legislation.

**Installation Procedure**

Ensure mains supply is turned off. Locate luminaire, use the mounting bracket as a template to drill fixing holes. Secure the bracket into position using suitable fixings. Prepare wiring, using suitable cable for the application. When securing this product to a wall, please remember to allow enough cable to tilt the luminaire to its final resting position. Never allow the mains wiring to become strained.

Remove the terminal cover from the back of the fitting.

Terminate the wiring.

Class I Product so this luminaire **must** be earthed.

Reinstall the terminal cover ensuring the seal is in place and seated correctly.

**DO NOT use power drivers to tighten terminal cover screws as this can cause damage to the terminal cover and invalidate the warranty!**

Adjust the angle of tilt to the required position and tighten bolts.

This product can be used as a wall washer if required,

Please note that the fitting is only suitable for wall lighting at a 45° Angle, this is to prevent water sitting on the fitting for prolonged periods of time. Fig 2.

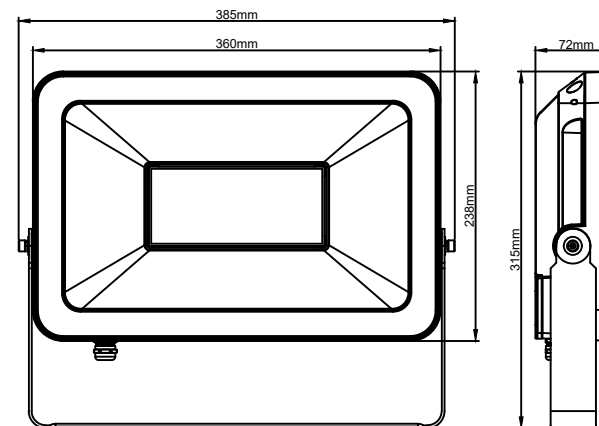
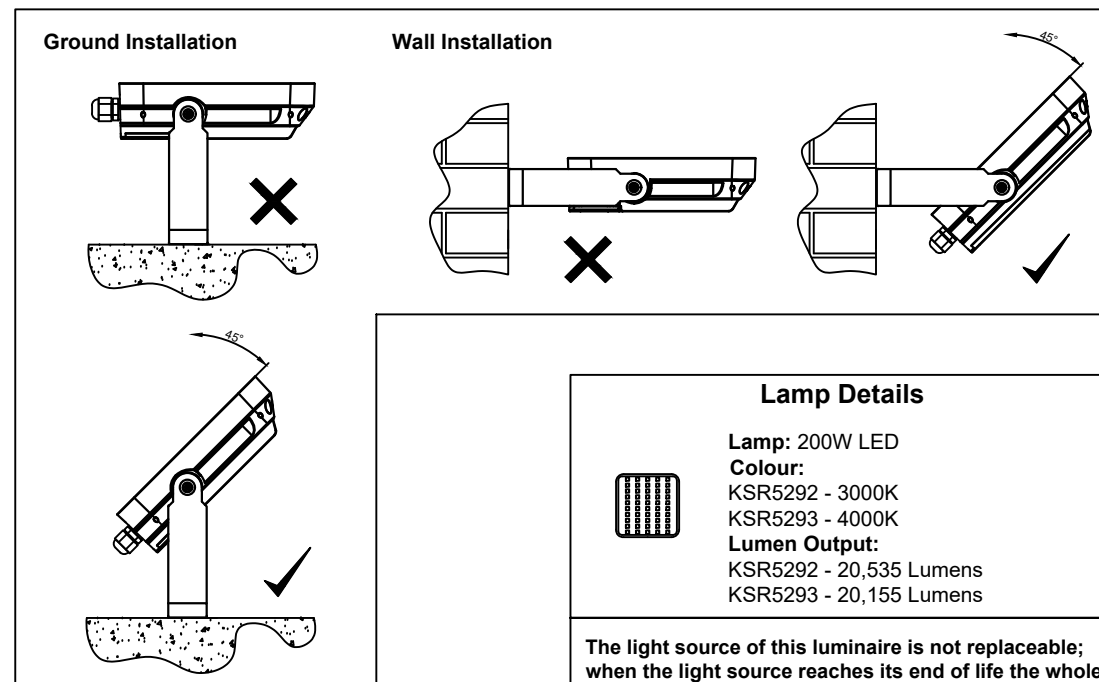
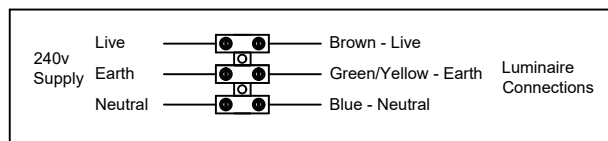

Fig.2



Lamp Details	
	<b>Lamp:</b> 200W LED
	<b>Colour:</b> KSR5292 - 3000K KSR5293 - 4000K
	<b>Lumen Output:</b> KSR5292 - 20,535 Lumens KSR5293 - 20,155 Lumens
	<b>The light source of this luminaire is not replaceable; when the light source reaches its end of life the whole luminaire shall be replaced</b>



This product contains a light source of energy efficiency class F

KSR Lighting Aftersales: 023 92 674343

E-mail: aftersales@ksrlighting.com